

Description

The P4KE series is designed specifically to protect sensitive electronic equipment from voltage transients induced by lightning and other transient voltage events.

Features

- Fast response time
- Matte tin lead-free Plated
- Low incremental surge resistance
- Halogen free and RoHS compliant
- Typical I_R less than $1\mu A$ above 10V
- Compatible with industrial standard package DO-41
- 400W peak pulse power capability with at 10/1000 μs waveform, repetition rate (duty cycle): 0.01%
- High temperature soldering guaranteed: 260°C/10 seconds



Electrical symbol

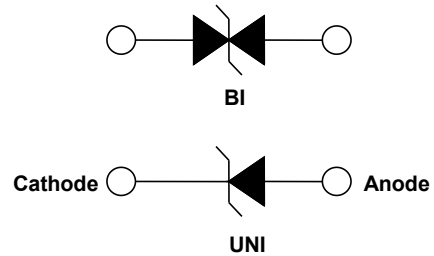

Part Number Code

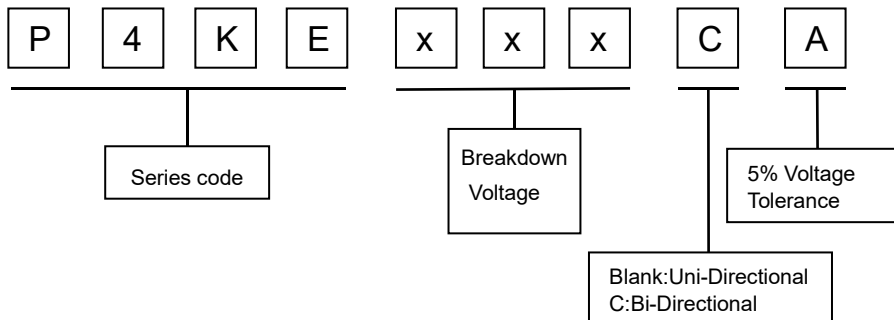

Mechanical Characteristics

Rating	Symbol	Value	Units
Peak Pulse Power Dissipation by 10x1000 μs test Waveform (Fig.2)(Note1)	P_{PP}	400	W
Steady State Power Dissipation on infinite heat sink at $T_L=75^\circ C$ (Fig.6)	P_D	5.0	W
Peak Forward Surge Current, 8.3ms Single Half Sine Wave Unidirectional only (Note 2)	I_{FSM}	100	A
Maximum instantaneous forward voltage at 25A for unidirectional only	V_F	3.5/6.5	V
Operating junction and Storage Temperature Range.	T_J, T_{STG}	-55 to 150	$^\circ C$

Notes:

1. Non-repetitive current pulse, per Fig.4 and derated above $T_A = 25^\circ C$ per Fig. 3.
2. Measured on 8.3ms single half sine wave or equivalent square wave, duty cycle=4 per minute maximum.

Electrical Characteristics

Type Number		Reverse Stand-Off Voltage	Breakdown Voltage		Test Current	Max. Clamping Voltage 10/1000µs	Max. Peak Pulse Current 10/1000µs	Reverse Leakage
			V _{BR} @I _T					
		UNI	BI	V _{RWM}	Min	Max	I _T	V _C @I _{PP}
		V	V	V	mA	V	A	µA
P4KE6.8A	P4KE6.8CA	5.80	6.45	7.14	10	10.5	39.0	300
P4KE7.5A	P4KE7.5CA	6.40	7.13	7.88	10	11.3	36.3	200
P4KE8.2A	P4KE8.2CA	7.02	7.79	8.61	10	12.1	33.9	100
P4KE9.1A	P4KE9.1CA	7.78	8.65	9.55	1	13.4	30.6	50
P4KE10A	P4KE10CA	8.55	9.50	10.50	1	14.5	28.3	10
P4KE11A	P4KE11CA	9.40	10.5	11.60	1	15.6	26.3	1
P4KE12A	P4KE12CA	10.20	11.4	12.60	1	16.7	24.6	1
P4KE13A	P4KE13CA	11.10	12.4	13.70	1	18.2	22.5	1
P4KE15A	P4KE15CA	12.80	14.3	15.80	1	21.2	19.3	1
P4KE16A	P4KE16CA	13.60	15.2	16.80	1	22.5	18.2	1
P4KE18A	P4KE18CA	15.30	17.1	18.90	1	25.5	16.1	1
P4KE20A	P4KE20CA	17.10	19.0	21.00	1	27.7	14.8	1
P4KE22A	P4KE22CA	18.80	20.9	23.10	1	30.6	13.4	1
P4KE24A	P4KE24CA	20.50	22.8	25.20	1	33.2	12.3	1
P4KE27A	P4KE27CA	23.10	25.7	28.40	1	37.5	10.9	1
P4KE30A	P4KE30CA	25.60	28.5	31.50	1	41.4	9.9	1
P4KE33A	P4KE33CA	28.20	31.4	34.70	1	45.7	9.0	1
P4KE36A	P4KE36CA	30.80	34.2	37.80	1	49.9	8.2	1
P4KE39A	P4KE39CA	33.30	37.1	41.00	1	53.9	7.6	1
P4KE43A	P4KE43CA	36.80	40.9	45.20	1	59.3	6.9	1
P4KE47A	P4KE47CA	40.20	44.7	49.40	1	64.8	6.3	1
P4KE51A	P4KE51CA	43.60	48.5	53.60	1	70.1	5.8	1
P4KE56A	P4KE56CA	47.80	53.2	58.80	1	77.0	5.3	1
P4KE62A	P4KE62CA	53.00	58.9	65.10	1	85.0	4.8	1
P4KE68A	P4KE68CA	58.10	64.6	71.40	1	92.0	4.5	1
P4KE75A	P4KE75CA	64.10	71.3	78.80	1	103.0	4.0	1
P4KE82A	P4KE82CA	70.10	77.9	86.10	1	113.0	3.6	1
P4KE91A	P4KE91CA	77.80	86.5	95.50	1	125.0	3.3	1
P4KE100A	P4KE100CA	85.50	95.0	105.00	1	137.0	3.0	1
P4KE110A	P4KE110CA	94.00	105.0	116.00	1	152.0	2.7	1
P4KE120A	P4KE120CA	102.00	114.0	126.00	1	165.0	2.5	1
P4KE130A	P4KE130CA	111.00	124.0	137.00	1	179.0	2.3	1

Electrical Characteristics

Type Number		Reverse Stand-Off Voltage	Breakdown Voltage		Test Current	Max. Clamping Voltage 10/1000µs	Max. Peak Pulse Current 10/1000µs	Reverse Leakage
			V _{BR} @I _T					
		UNI	BI	V _{RWM}	Min	Max	I _T	V _C @I _{PP}
		V	V	V	mA	V	A	µA
P4KE150A	P4KE150CA	128.00	143.0	158.00	1	207.0	2.0	1
P4KE160A	P4KE160CA	136.00	152.0	168.00	1	219.0	1.9	1
P4KE170A	P4KE170CA	145.00	162.0	179.00	1	234.0	1.8	1
P4KE180A	P4KE180CA	154.00	171.0	189.00	1	246.0	1.7	1
P4KE200A	P4KE200CA	171.00	190.0	210.00	1	274.0	1.5	1
P4KE220A	P4KE220CA	185.00	209.0	231.00	1	328.0	1.3	1
P4KE250A	P4KE250CA	214.00	237.0	263.00	1	344.0	1.2	1
P4KE300A	P4KE300CA	256.00	285.0	315.00	1	414.0	1.0	1
P4KE350A	P4KE350CA	300.00	332.0	368.00	1	482.0	0.85	1
P4KE400A	P4KE400CA	342.00	380.0	420.00	1	548.0	0.75	1
P4KE440A	P4KE440CA	376.00	418.0	462.00	1	602.0	0.68	1

I-V Curve Characteristics

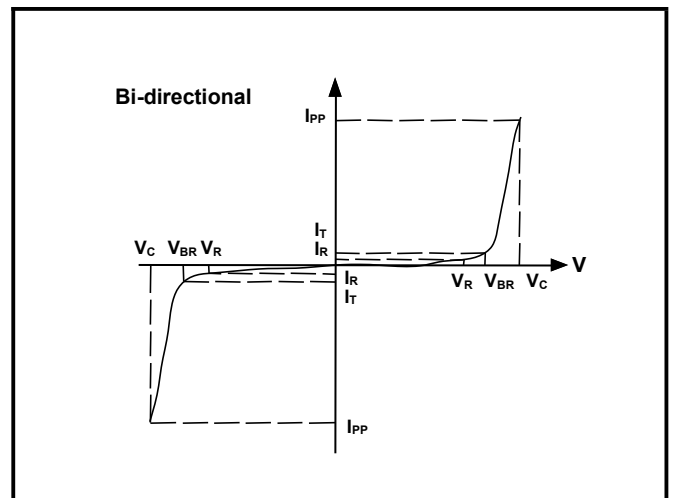
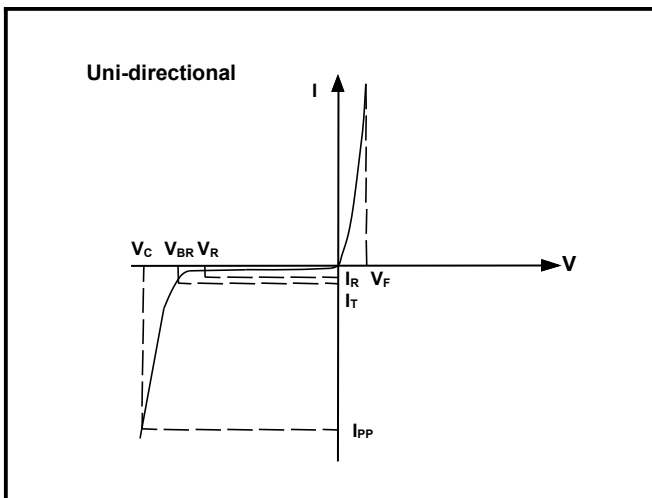

P_{PPM} Peak Pulse Power Dissipation -- Max power dissipation

V_R Stand-off Voltage -- Maximum voltage that can be applied to the TVS without operation

V_{BR} Breakdown Voltage -- Maximum voltage that flows though the TVS at a specified test current (I_T)

V_C Clamping Voltage -- Peak voltage measured across the TVS at a specified I_{ppm} (peak impulse current)

I_R Reverse Leakage Current – Current measured at V_R

V_F Forward Voltage Drop for Uni-directional

Ratings and Characteristic Curves ($T_A=25^\circ\text{C}$ unless otherwise noted)

Figure 1 - TVS Transients Clamping Waveform

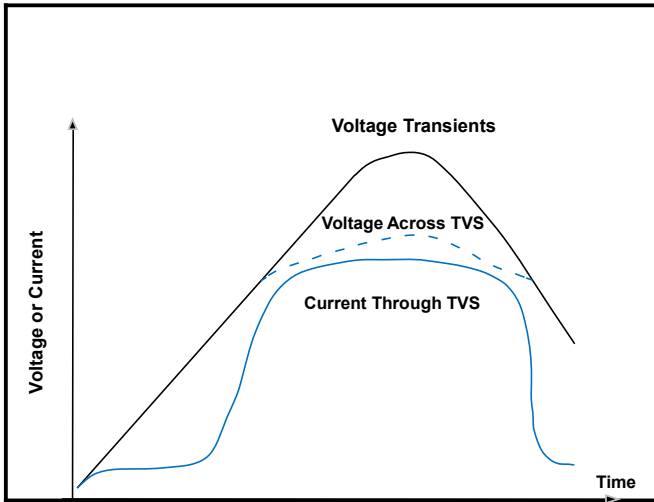

Figure 2 - Peak Pulse Power Rating Curve

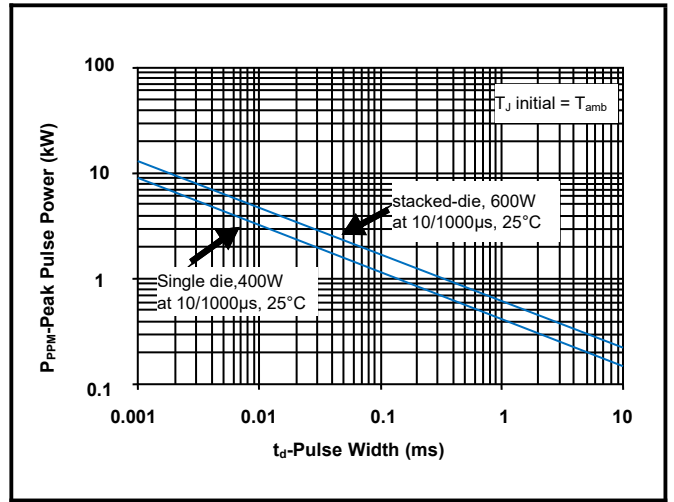

Figure 3 - Pulse Derating Curve

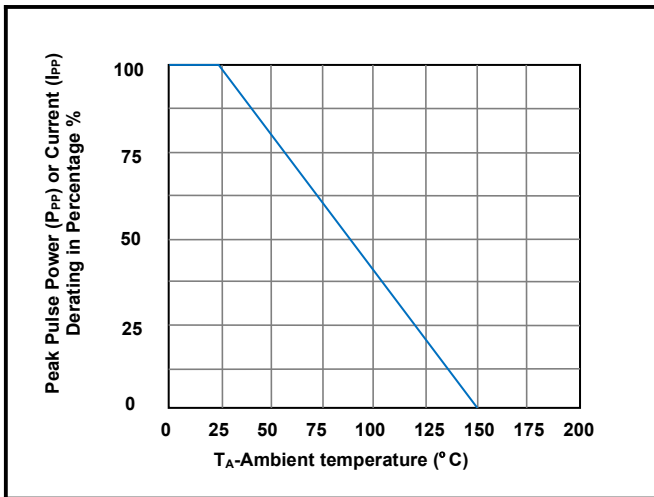

Figure 4 - Pulse Waveform

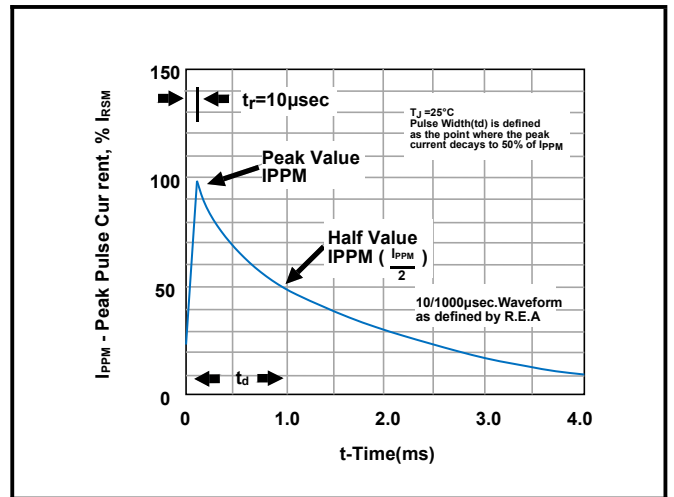

Figure 5 - Typical Junction Capacitance

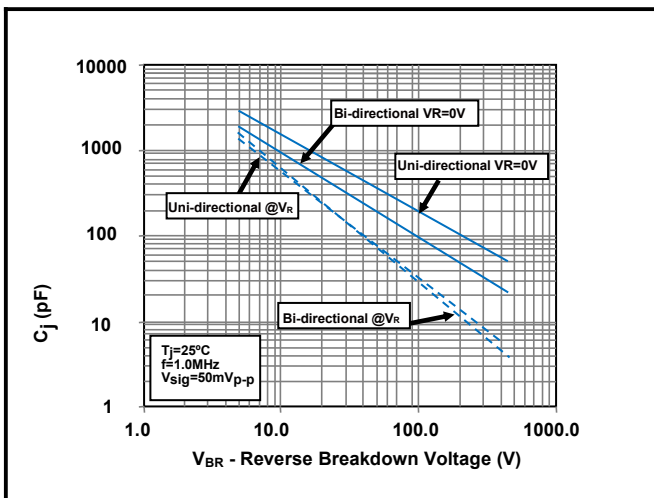

Figure 6 - Steady State Power Derating Curve

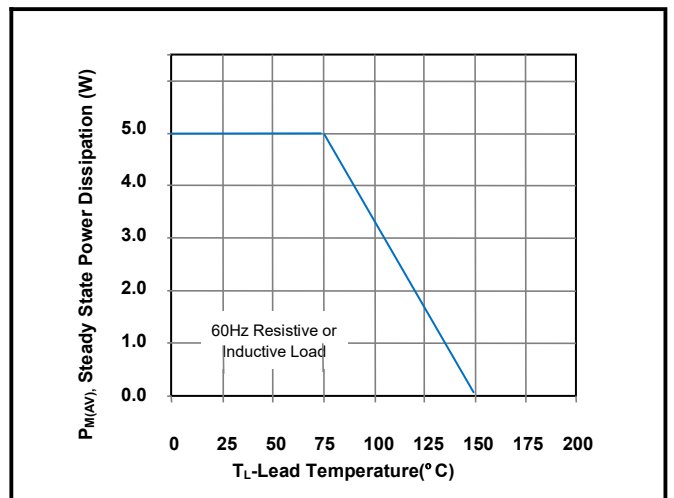
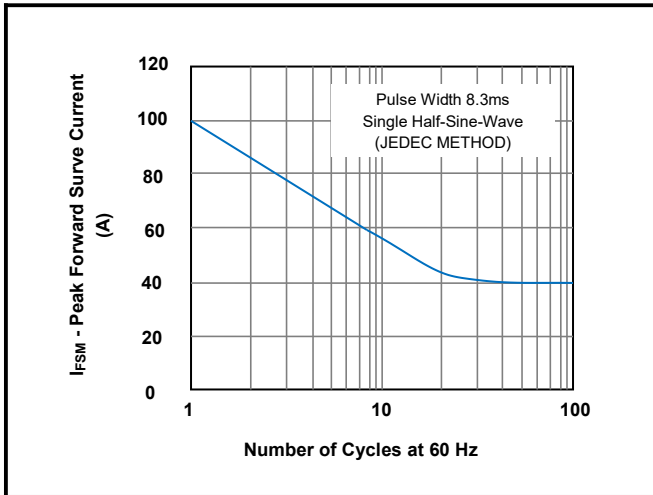
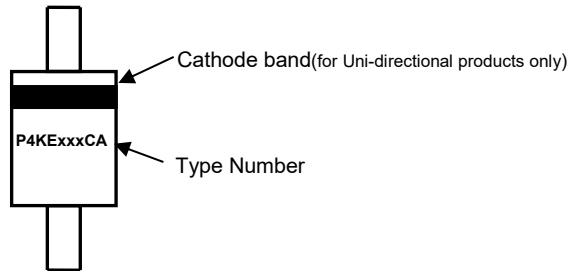

Figure 7 - Maximum Non-Repetitive Surge Current



Part Marking System



Dimensions

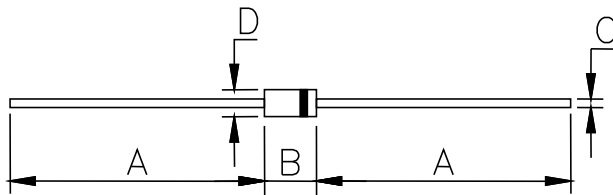

DIM	Millimeters		Inches	
	Min	Max	Min	Max
A	25.40	-	1.000	-
B	4.20	5.20	0.165	0.205
C	0.70	0.90	0.028	0.035
D	2.00	2.70	0.079	0.106

Packaging Information

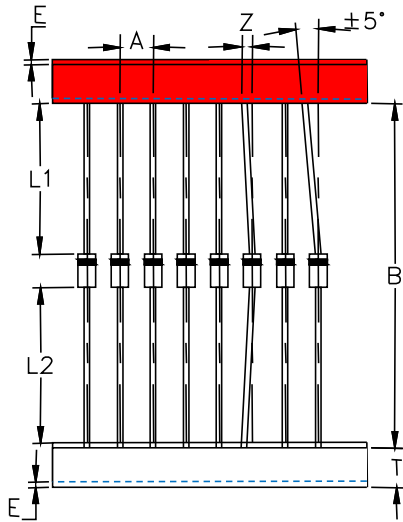

Symbol	Millimeters	Inches
A	5.08±0.5	0.2±0.019
B	53.0±1.0	2.087±0.039
Z	1.2Max	0.047 Max
T	6.0±0.4	0.236±0.015
E	0.8Max	0.031 Max
L1-L2	1.0Max	0.039 Max

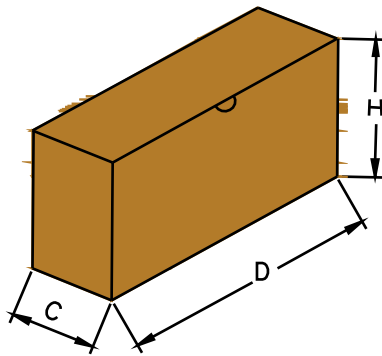

Symbol	Millimeters	Inches
D	250.0±5.0	9.843±0.197
C	75.0±5.0	2.953±0.197
H	114.0±5.0	4.488±0.197
Quantity	3000PCS / inner box	